

COUNTERTOP GAS GRIDDLES

Manual Control

Model	Product ID	Controls	Burners
KGR36M	919573	Manual	3

STANDARD FEATURES

- High performance & efficient 30,000 BTU stainless steel U style burners provide flame every 6" on the griddle surface
- Stainless steel front & sides
- 3/4" highly polished griddle plate provides even heat distribution
- 4" high backsplash & sidesplash fully welded to the griddle
- Double wall construction w/ insulated side panels
- Extended cool to touch front edge
- Wide 3 1/4" front grease trough
- Removable, easy to clean stainless grease catch pan
- Large chrome temperature knobs w/ set screws
- Front-access pilots
- Adjustable non-skid stainless steel legs

WARRANTY

Kintera Gas Cooking Equipment is warranted to be free from defects in material and workmanship under normal use and service for a period of 1 year from the date of original purchase.



KGR36M
Gas Regulator Included

SPECIFICATIONS

The efficient 3/4" griddle plate offers the thickness of even heat distribution and retention. The result is faster cook times, greater moisture retention, higher product yield so you serve a higher quality, moist product.

Units are shipped for natural gas, but are easily converted to LP (propane) gas with the LP conversion kit that is included.

All Griddles carry ETL gas and sanitation approvals that pass US gas and sanitation requirements for use in restaurants.



IMPORTANT INFORMATION

- A pressure regulator is provided with this unit.
Natural Gas 4" (102 mm) W.C.
Propane Gas 10" (279 mm) W.C.
- All equipment is supplied for Natural Gas, an LP conversion kit is also provided.
- 3/4" NPT (19mm) rear gas connection.

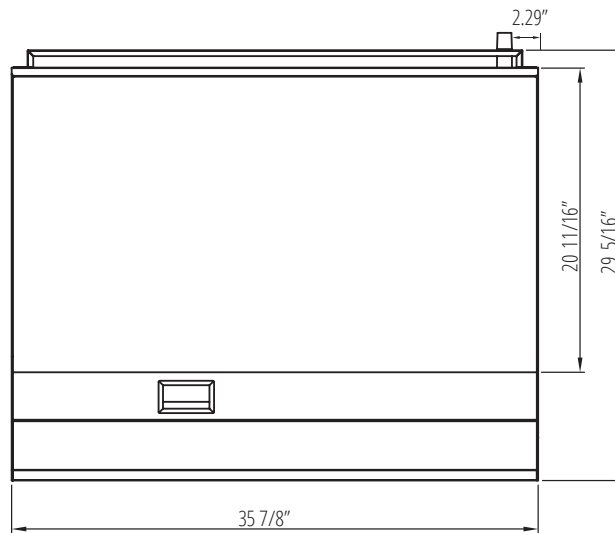
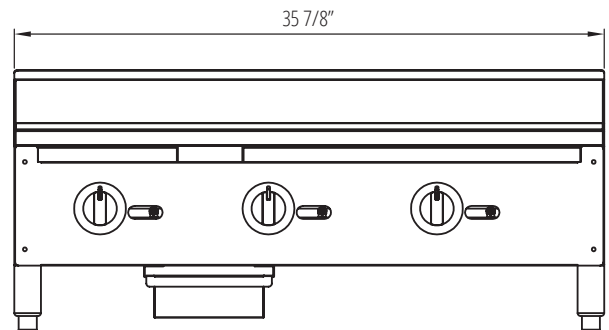
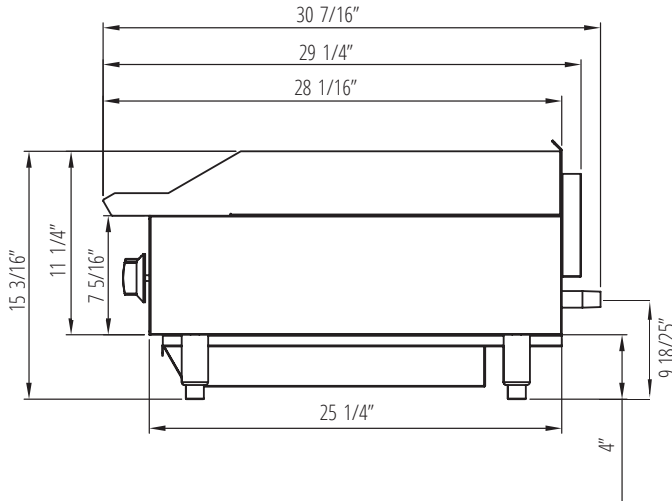

Model	Prouct ID	Burners	Cooking Area (in)		Plate Thickness	Dimensions (in)			BTU's (per burner)	Total BTU's	Crated Weight (lbs)
			D	W		W	D	H			
KGR36M	919573	3	20 11/16	35 7/8	3/4"	35 7/8	30 7/16	15 3/16	30,000	90,000	274